

Sec: A - A

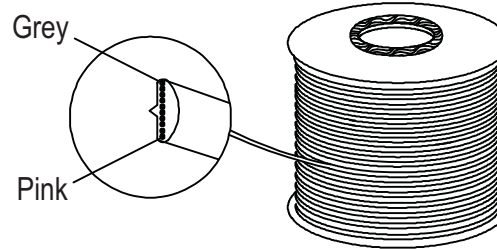

1,000Ft/R. "PE" Foam Wrapped

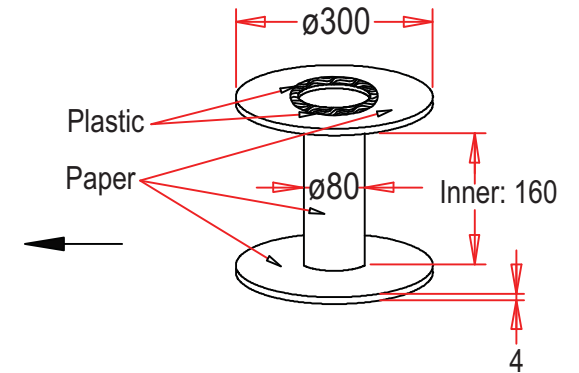

Unit: MM



ITEM NO.	AT-K-26-10-S/1000-R
TITLE	Modular Straight cable - Raw, 10 Contact, 26AWG, Silver, 1,000Ft

ASSMANN
 Electronics, Inc.

1840 W. Drake Drive, Suite 101 • Tempe, AZ 85283
 Toll Free: 1-877-277-6266 • Email: info@usa-assmann.com

THIS DRAWING IS UNPUBLISHED
 ©Copyright 2011 by Assmann Electronic Components
 All International Rights Reserved